

Operation Manual

v1.0

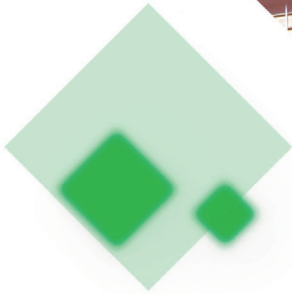

micro
line

MLF-100

4 x DVB-S/S2/T/T2/C to 4 x DVB-T/C





1. IMPORTANT SAFETY PRECAUTIONS INFORMATION

READ THE FOLLOWING WARNINGS BEFORE YOU USE YOUR DEVICE

WARNING

The following safety precautions must be observed to prevent fire or electric shock hazard. Safety precautions include but are not restricted to the following:

Power supply / Mains cord

- ▶ Operate the unit only within the voltage range defined as appropriate by the manufacturer.
- ▶ Occasionally check the power connector and remove dirt or dust that may have accumulated.
- ▶ Use only the mains cord that comes with your unit.
- ▶ Do not operate the unit or plug in the mains cord if it is broken, split, or damaged in any way.
- ▶ Do not place the mains cord next to heating devices. Do not pull it, place heavy objects on it or damage it in any way. Keep it out of reach of children.
- ▶ Ensure that the device is plugged in a properly grounded socket. Insufficient grounding may cause electrocution.
- ▶ Always carefully disconnect all plugs by pulling on the plug and not on the cord. Make sure the unit's power switch is turned off before removing the cord from an outlet.
- ▶ Disconnect the mains cord when the unit is not in use for long periods of time or during storms.
- ▶ Do not connect the unit to a multiple-outlet to avoid plug overheating.

Disassembling

- ▶ This unit contains parts that cannot be repaired by the user. Do not disassemble or try to repair it as this will void all warranties. Please contact the manufacturer if you experience any problems with your unit.

Water/humidity

- ▶ Do not keep the unit in a humid place or near water.
- ▶ Do not plug/unplug the unit with wet hands.



Fire

- ▶ Never place a candle or another source of fire on the unit as it may fall and start a fire.
- ▶ If the mains cord or the power connector is damaged or destroyed, or if there is a sudden loss of picture during operation, or if you notice a strange smell or there is smoke, immediately switch the unit off, disconnect the mains cord and contact the manufacturer's technical support department.

Installation / Storage

- ▶ This unit contains high precision pieces of electronics. To ensure optimal performance and avoid damage, do not store it in any location where it may collect dirt, dust, lint, etc. Do not expose it to extreme heat or cold (e.g. in direct sunlight, near a heater or in the car during the day). Place the unit in a secure place to avoid falls.
- ▶ Before moving the unit, always unplug all cords first.
- ▶ When installing the unit, make sure that an outlet is within easy reach. In case of malfunction, switch the unit off and unplug the power cord. When the unit is not in use for a long period of time, make sure that the mains cord is disconnected.

Connectivity

- ▶ Before connecting the unit to other electronic devices, always switch off and unplug all devices.

Maintenance

- ▶ Do not spill liquids on the unit. Do not use any diluents or volatile liquid to clean the unit. Instead, use a soft slightly damp cloth and allow the unit to dry completely before using again.

Handling

- ▶ Do not poke your finger into the openings on your unit.
- ▶ Never put paper, metal parts or other objects into the openings of your unit. If you suspect that there are foreign parts in your unit, switch it off and unplug the mains cord. Contact the manufacturer's technical support department.
- ▶ Do not step on or place heavy objects on top of the unit. To avoid hardware damage, handle all buttons, connectors and switches gently.



2. INTRO

Congratulations on purchasing the MLF-100. You now own a high quality, professional DTV headend. To get the most out of your purchase, please take the time to carefully read through this manual.

3. INSTRUCTIONS

3.1 - Description

The MLF-100 is a very powerful, all-in-one device, able to receive up to 4 independent satellite (DVB-S/S2), terrestrial (DVB-T/T2) or cable (DVB-C) signals and convert them in 4 x DVB-T/C RF output channels. It supports "pool" technology, meaning that the user is able to select any program from any of the 4 inputs and assign it to any of the 4 RF providing great flexibility.

The embedded web server of the MLF-100 provides a very friendly user interface as well as the ability of remote or local control of the device via Ethernet.

Its small size and its powerful features renders the MLF-100 the ideal solution in cases we want to distribute FTA (Free-To-Air) TV programs coming from satellite (DVB-S/S2), terrestrial (DVB-T/T2) or cable (DVB-C) sources to a CATV installation using the DVB-T/C technology.

3.2 - Features

- ▶ 4 x independent multi-standard inputs DVB-S/S2/T/T2/C
- ▶ 4 x RF output DVB-T/C (software selectable)
- ▶ "Pool" technology
- ▶ MER value > 42dB
- ▶ Dual power supplies offering redundancy mode
- ▶ PID Filtering
- ▶ Custom NIT/SDT
- ▶ Local or remote control via webserver
- ▶ Very friendly user interface
- ▶ Wall or rack mount options
- ▶ SNMP v2
- ▶ Ultra-compact size
- ▶ 5year warranty

3.2.1 - Auto-reset functions and watchdog

During the normal operation of the MLF-100, the main CPU monitors all the internal parts in order to ensure that the device works normally. In case of an internal error or module failure, the MLF-100 immediately initiates the recovery procedure by resetting the appropriate module or the device. Finally, watchdog timers ensure that the device will be reset in case of CPU failure.



3.2.2 - "Pool" technology

The MLF-100 supports "pool" technology, meaning that the user is able to select any TV or Radio program from any input and assign it to any of the 4 outputs providing great flexibility.

3.2.3 - DVB-T or DVB-C compliant

The user is able to software select the modulation standard, between DVB-T and DVB-C, of the MLF-100 without the need of any firmware upgrade.

3.2.4 - Custom NIT/SDT

Using the MLF-100 the user is able to create custom NIT and SDT tables according to his needs.

3.2.5 - Dual power supplies

The MLF-100 is powered from one or two external power supplies of +12VDC/2.5A. In case we connect two external power supplies then they will work in redundancy mode. Thus, in case of failure of one of the two external power supplies the device will continue working without stopping.

3.3 - Block Diagram

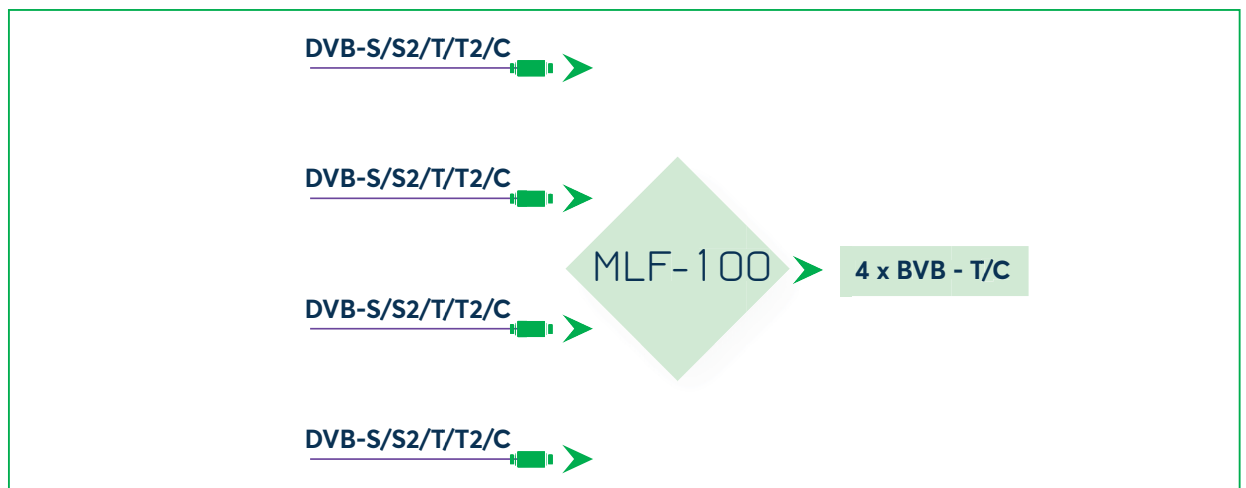



3.4 - Product drawing views

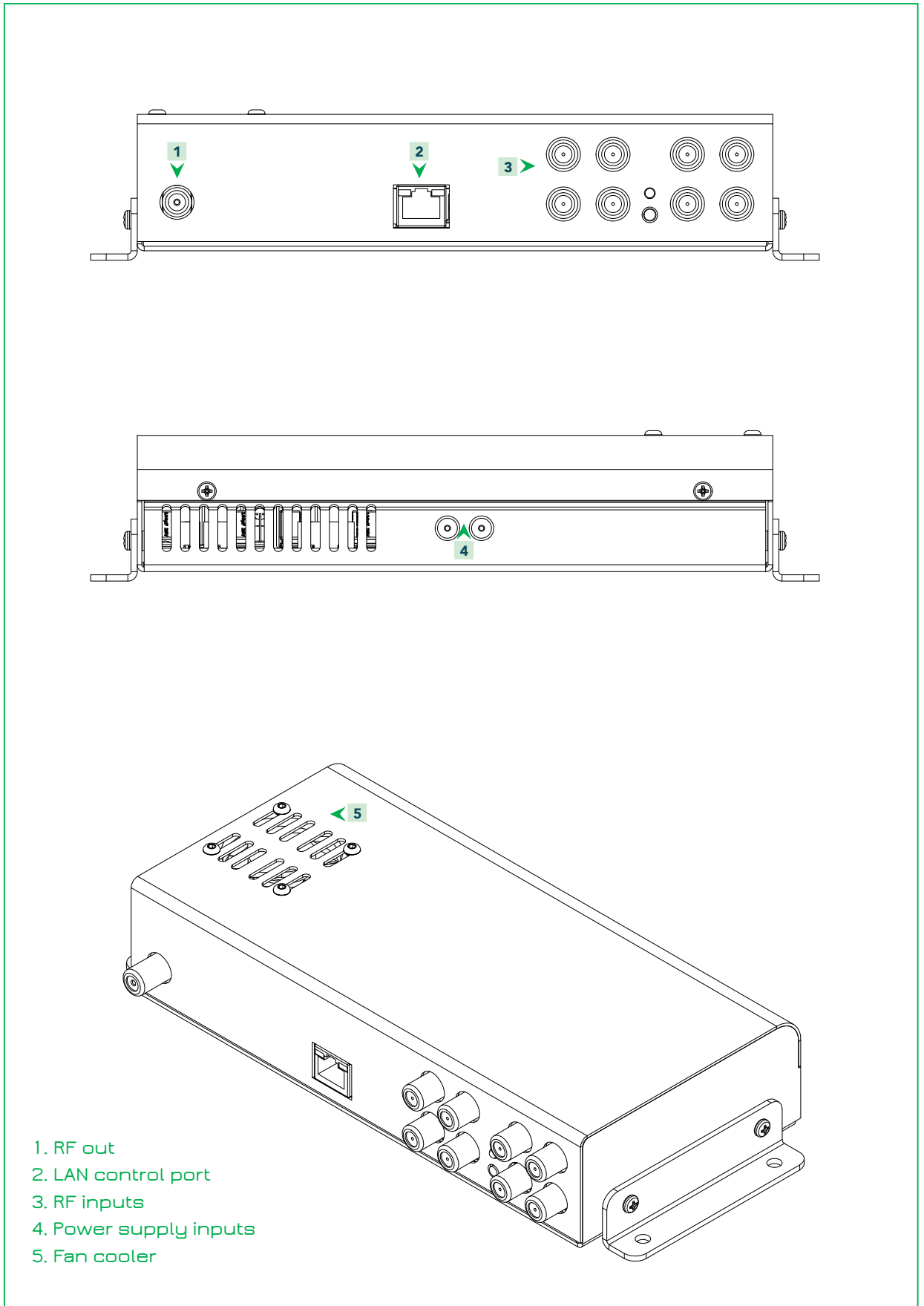



4. INSTALLATION

4.1 - General

The MLF-100 has a very friendly interface for programming and monitoring purposes. The user is able to gain access to the embedded webserver, by opening an Internet browser (e.g. Internet Explorer, Firefox or Chrome) and type the following static IP: **192.168.1.205**.

The default username and password are the following:

Username: admin
Password: 12345

4.2 - Embedded Webserver

Status

4.2.1 - "General" page

Every time that the user is connected to the device, the "General" page (Figure No 1) is loaded providing a current general status information of the device.

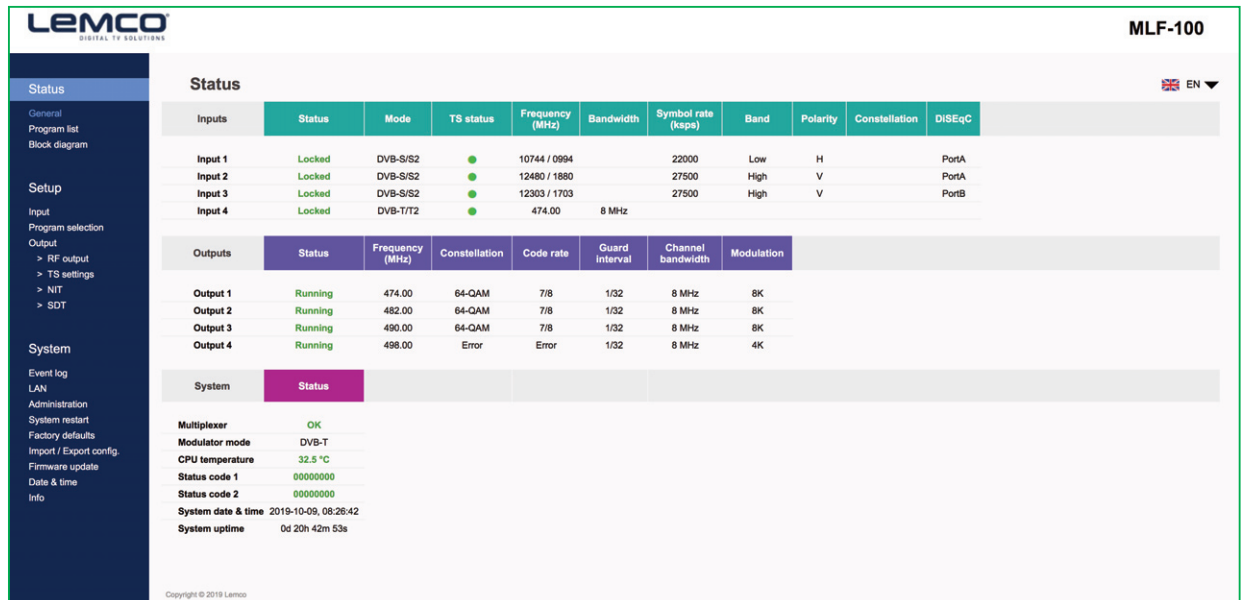

Figure No 1

Status - Inputs 1...4

In these fields, the user is able to see the status of each tuner e.g. If it is locked / unlocked or disabled, the working mode eg. DVB-S/S2, DVB-T/T2 or DVB-C etc.



Outputs – Modulator 1...4

In these fields, the user is able to see the status of all the RF outputs of the device such as modulator’s state, RF output frequencies and modulation settings.

System

This section provides general information of the device, like internal status of all device’s modules, CPU temperature and fan state as well as error codes for troubleshooting purposes.

4.2.2 - “Program list” page

In “Program list” page (Figure No 2) the MLF-100 provides information of all programs that are currently being distributed via its four RF outputs.

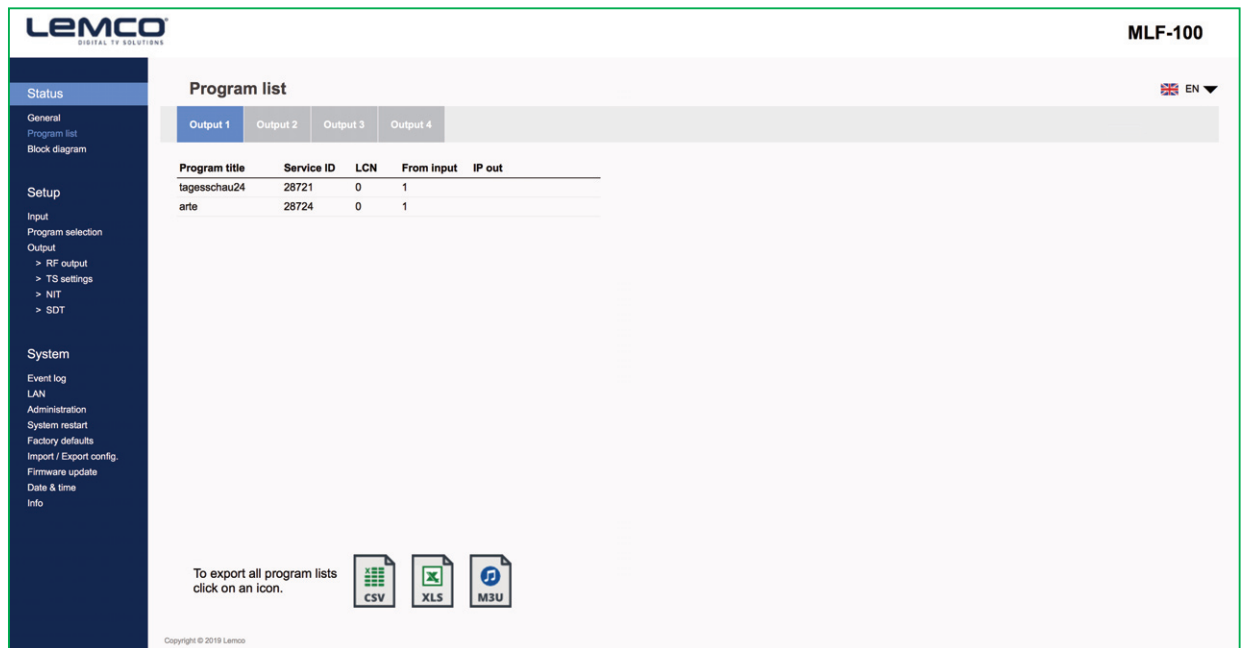

Figure No 2

At the same time, the device offers the whole channel list to be exported under the follow file types:

- Excel – All the program list is exported in .xlsx format
- CSV – All the program list is exported in .csv format
- M3U – All the program list is exported in .m3u

4.2.3 - “Block diagram” page

The “Block diagram” page (Figure No 3) provides a general view of device’s internal modules and architecture.

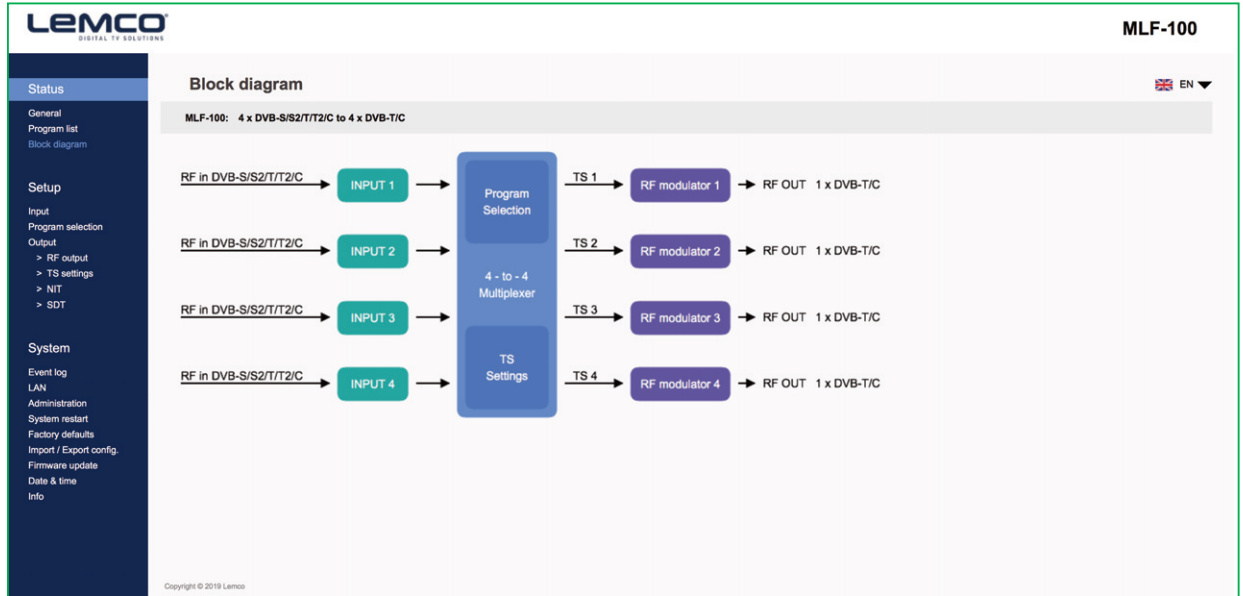

Figure No3

All icons are clickable providing the ability to the user to go directly to the setup page of all internal modules of the device. The grey icons mean that the current module is disabled.

Setup

4.2.4 - "Input" page

In the "Input" page (Figure No 4) the user is able to select the working mode for each input.

The screenshot displays the 'Input' configuration page for the MLF-100. The left sidebar shows the navigation menu with 'Input' selected. The main content area is divided into 'Settings' and 'Status' panels. The 'Settings' panel includes fields for Tuner (DVB-S/S2), Frequency (10744 MHz), Symbol rate (22000 kps), LNB voltage (Horizontal (18V)), Band (Low), and DiSEqC (Port A). The 'Status' panel shows Tuner (Locked), Bit rate (34387 Kbps), Signal strength (57%), and Signal quality (66%). There are 'Apply' and 'Refresh' buttons at the bottom of the settings, and a 'Refresh' button with a dropdown for frequency (Every 5 sec) and a 'Now' button at the bottom of the status panel. The top of the page shows the device name 'MLF-100' and a language selector set to 'EN'.

Figure No 4



There are four tabs, one for each input. The user is able to select the working mode of each input as follows:

For Satellite signal reception the user must select DVB-S/S2 mode:

1. Tuner Enabled/Disabled - Enable or disable the specific tuner
2. SAT or IF frequency – Select how to insert the SAT frequency
3. Symbol rate – Insert the symbol rate
4. LNB voltage – Select the LNB voltage (13V,18V,OFF)
5. Band – Select the appropriate SAT band (works only if IF frequency is selected as input method)
6. DiSEqC – Select DiSEqC A, B, C, D

For Terrestrial signal reception the user must select DVB-T/T2 mode:

1. Tuner Enabled/Disabled - Enable or disable the specific tuner
2. Frequency – Insert the input frequency or
3. Channel – Instead of frequency your can add the channel number
4. Bandwidth – Insert the input channel bandwidth

For DVB-C mode:

1. Tuner Enabled/Disabled - Enable or disable the specific tuner
2. Frequency – Insert the input frequency
3. Symbol rate – Insert the symbol rate
4. Constellation – Insert constellation

Once all settings are being written for both tuners, the user must click the “Apply” button to begin the lock process.

Tuner status

For each input the MLF-100 provides several information such as tuner status (Locked/Unlocked), total bitrate, signal strength, quality etc.

4.2.5 - “Program Selection” page

In the “Program Selection” page (Figure No 5) the user is able to select any program from any input and assign it to any output using the “pool” technology.

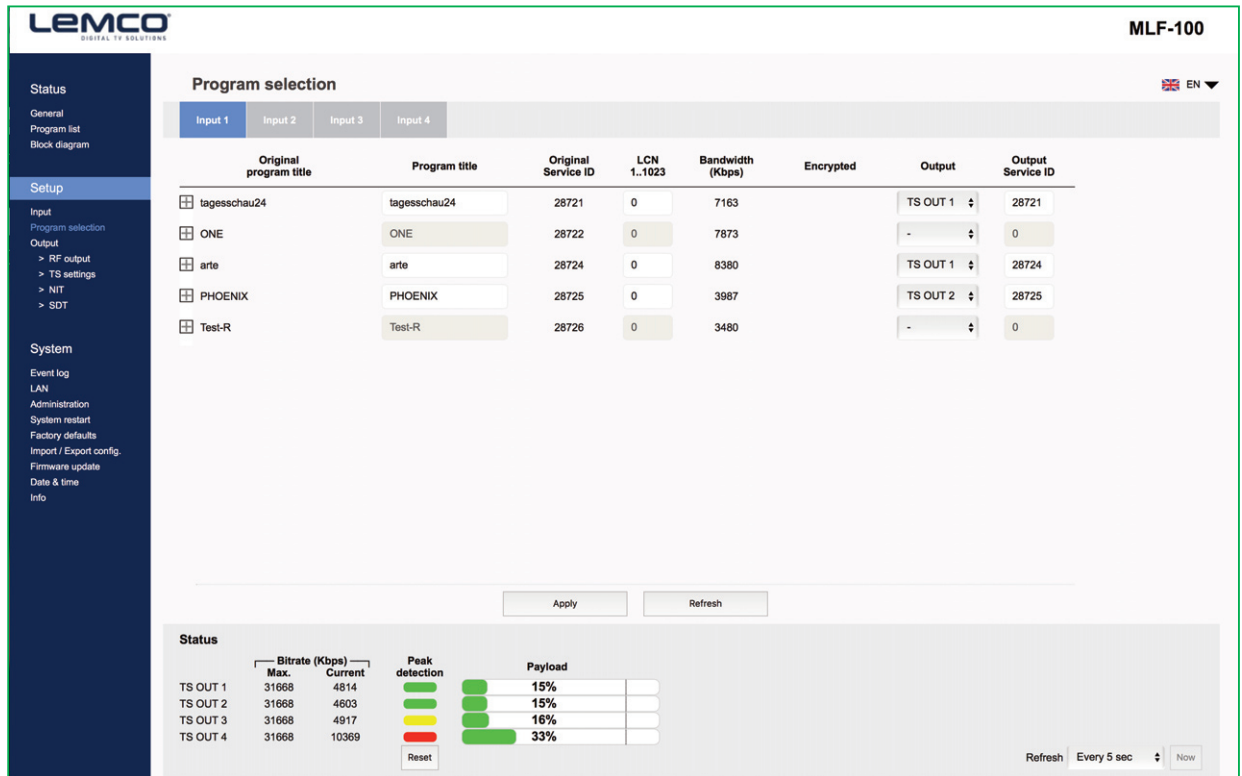

Figure No 5

There are 4 tabs, one for each input. Each tab depicts all the TV and Radio programs from the input that has being selected during the "Input page" processes.

When the user selects one input, the device's multiplexer does a real time analysis and depicts the program list from this specific input. For each program the MLF-100 provides the following information/options:

- ▶ Original Program Title – which is the name of the program
- ▶ Program Title – The ability to enter a custom name for this specific program
- ▶ Original Service ID – which is the original Service ID number of the program
- ▶ LCN No – which is the logic channel number of the program
- ▶ Bandwidth – which is the bitrate of the program in Kbps
- ▶ Encrypted – which depicts if the program is encrypted or not
- ▶ Output – To select in which the program must be assigned
- ▶ Output Service ID – The user is able to provide custom Service ID number

Each program title has a small cross at the left which can be expanded if the user will click on it. During this procedure, all the available PIDs of this specific program are revealed (Figure No 6). In this case, the user is able to select/deselect which PID want to be outputted.



Original program title	Program title	Original Service ID	LCN 1..1023	Bandwidth (Kbps)	Encrypted	Output	Output Service ID
tagesschau24	tagesschau24	28721	0	7163		TS OUT 1	28721
ONE	ONE	28722	0	7873		-	0
arte	arte	28724	0	8380		TS OUT 1	28724
PHOENIX	PHOENIX	28725	0	3987		TS OUT 2	28725
Test-R	Test-R	28726	0	3480		-	0

TS OUT	Bitrate (Kbps)		Peak detection	Payload
	Max.	Current		
TS OUT 1	31668	3498	11%	
TS OUT 2	31668	6334	20%	
TS OUT 3	31668	9401	30%	
TS OUT 4	31668	1637	5%	

Figure No 6

Using the Drop-down menu from "Output" column (Figure No 7) the user is able to assign any program to any of the four outputs. By doing the same process for each program, from all inputs the user is able to create his own 4 custom multiplex in the output.

Original program title	Program title	Original Service ID	LCN 1..1023	Bandwidth (Kbps)	Encrypted	Output	Output Service ID
tagesschau24	tagesschau24	28721	0	7163		TS OUT 1	28721
ONE	ONE	28722	0	7873		-	0
arte	arte	28724	0	8380		TS OUT 1	28724
PHOENIX	PHOENIX	28725	0	3987		TS OUT 2	28725
Test-R	Test-R	28726	0	3480		-	0

Figure No 7



Caution!

The number of programs that the MLF-100 is able to distribute depends on the resolution (SD, HD, 4K etc.), the compression (MPEG2, H.264 etc...) and in general from the total bitrate of each program.

For example, if we select the following DVB-T setting for the four modulators on MLF-100 outputs:

- ▶ Constellation: 64 QAM
- ▶ Guard Interval: 1/32
- ▶ Code rate: 7/8
- ▶ Bandwidth: 8 MHz

According to Appendix A we will have a total output bitrate of 31.67Mbps/ modulator. That means that we can select as many programs as the user wants but their total bitrate must not exceed the 31.67Mbps, otherwise artifacts may occur.

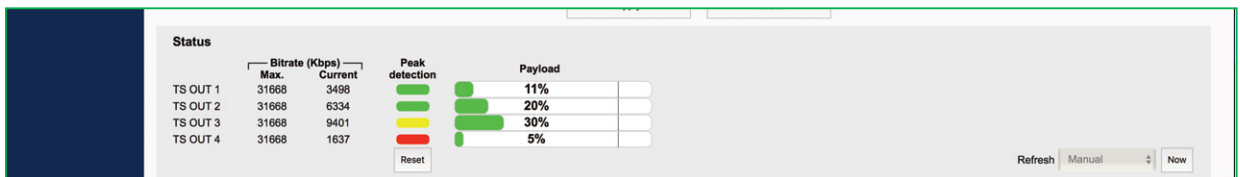

Figure No 8

The status section in (Figure No 8) provides a general idea to the user of the current payload (according to the selected programs) comparing it to the max. output payload.

It is recommended that the user must not exceed the 85% from each output, since all the bitrate are variable according to their specific content.

Peak Detection mechanismm

As shown in Figure No 8 there is a colored indicator of the peak detection mechanism, for each output transport stream. This indicates if any overflow has occurred on modulator's output bitrate with the following colors:

- ▶ Green – No overflow occurred
- ▶ Yellow – No overflow occurred but the input bitrate is close to the output bitrate
- ▶ Red – Overflow occurred. The user must decrease the input bitrate



4.2.6 - "RF Output" page

In the "RF Output" page (Figure No 9) the user is able to setup the RF output settings of the MLF-100.

The screenshot shows the 'RF output' configuration page for the MLF-100. It includes a sidebar with navigation options like 'Status', 'Setup', and 'System'. The main content area is titled 'RF output' and has radio buttons for 'DVB-C' and 'DVB-T'. Below this is a table for configuring four outputs:

	Frequency (MHz) 110.00 - 900.00	Constellation	Code rate	Guard interval	Channel bandwidth	Modulation	Enabled
Output 1	474.00	64-QAM	7/8	1/32	8 MHz	8K	<input checked="" type="checkbox"/>
Output 2	482.00	64-QAM	7/8	1/32	8 MHz	8K	<input checked="" type="checkbox"/>
Output 3	490.00	64-QAM	7/8	1/32	8 MHz	8K	<input checked="" type="checkbox"/>
Output 4	498.00			1/32	8 MHz	4K	<input checked="" type="checkbox"/>

Below the table is an 'Apply' button. The 'Output level' section has sliders for each output, all set to 95%.

The 'Status' section includes a table of current settings:

	Bitrate (Kbps)		Peak detection	Payload
	Max.	Current		
TS OUT 1	31668	6234	■	20%
TS OUT 2	31668	4078	■	13%
TS OUT 3	31668	9872	■	31%
TS OUT 4	31668	6799	■	21%

There is also a 'Refresh' button set to 'Every 2 sec' and a 'Reset' button.

Figure No 9

This block shows a partial view of the 'RF output' page, specifically the mode selection area with radio buttons for 'DVB-C' and 'DVB-T'.

With the use of the radio buttons the user is able to select the mode that the MLF-100 will operate as follows:

DVB-T: 4 x modulator working in DVB-T standard

DVB-C: 4 x modulator working in DVB-C standard

For each modulator in DVB-T mode the user is able to setup the following parameters:

- ▣ ▣ Frequency – The output frequency of the first modulator*
- ▣ ▣ Constellation – The constellation of the first modulator*
- ▣ ▣ Code Rate – The coder rate of the first modulator*
- ▣ ▣ Guard Interval - The guard interval of the first modulator*
- ▣ ▣ Channel Bandwidth – The channel bandwidth of the first modulator*
- ▣ ▣ Modulation – The modulation type of the first modulator*
- ▣ ▣ Enable/Disable – Enable or disable the current modulator
- ▣ ▣ Output level – Adjust the output level for each modulator from 70-90dBμV.



* All the four outputs of the MLF-100 operate in adjacent RF output channels. This means that the user setups only the first modulator and all the other three modulators have the same settings and automatically are being programmed in adjacent channels.

E.g. If the user sets the CH21 in UHF band on modulator No1 the other three modulators will be automatically set to CH22, CH23 and CH24, respectively.

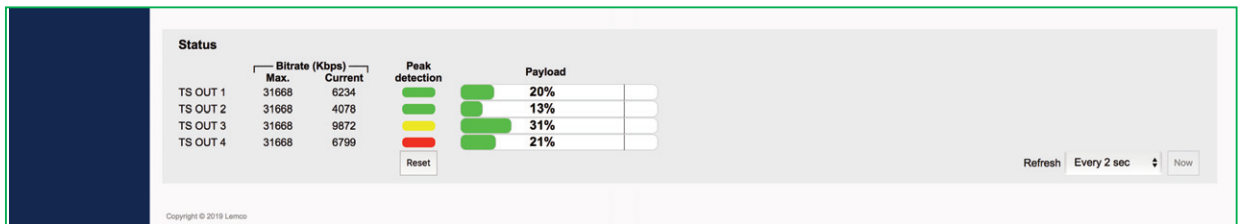

Figure No 10

The status section in (Figure No 10) provides a general idea to the user of the current payload (according to the selected programs) comparing to the max. output payload. It is recommended that the user must not exceed the 85% from each output, since all the bitrate are variable according to their specific content.

4.2.7 - "TS settings" page

In this section (Figure 11), the user is able to setup all the TS settings of the four multiplex in MLF-100's output.

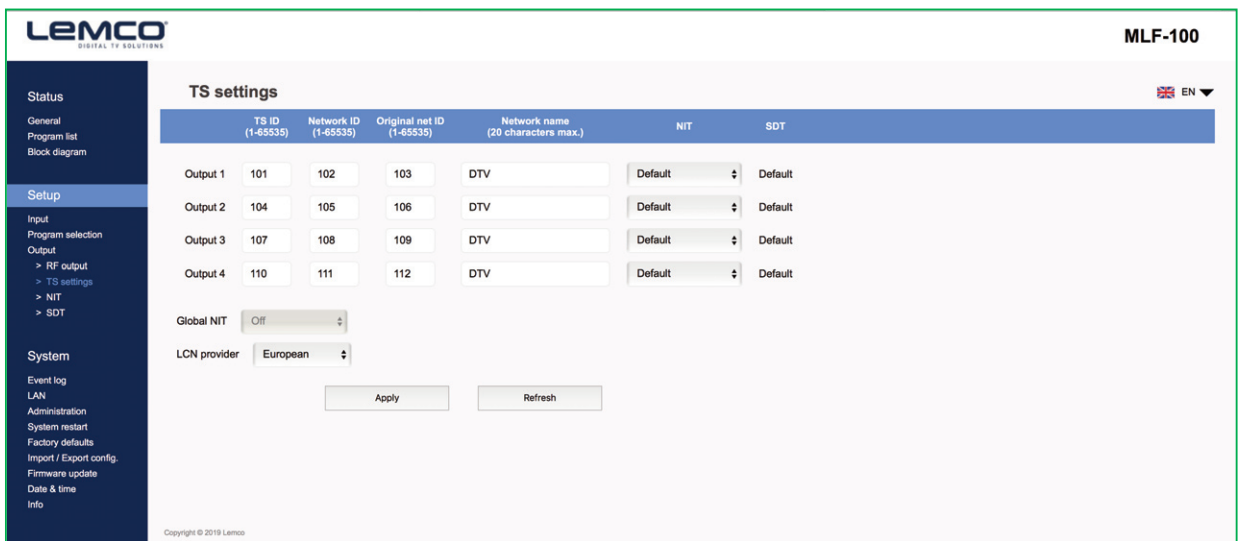

Figure No 11



For each multiplex output the user can setup the following settings:

- TS ID: Which is the ID No of the specific multiplex (1...65535)
- Net ID: Which is the Net ID No of the specific multiplex (1...65535)
- Original Net ID: Which is the Org. Net ID No of the specific multiplex (1...65535)
- Network Name: Which is the network name of the specific multiplex
- NIT: Choose from Global, Basic, Default and Custom
- LCN provider: Choose the appropriate LCN provider (EACEM, ITC, Nordig, APN)

4.2.8 - "NIT" page

In this section (Figure 12), the user is able to create custom NIT table for each of the four outputs of the device. Moreover, this section offers the ability to export / import a NIT table..

The screenshot displays the 'NIT - Network Information Table' configuration page. The interface includes a sidebar with navigation options like 'Status', 'Setup', and 'System'. The main content area shows configuration fields for 'NIT mode' (set to Default), 'Network name', 'Network ID', and 'LCN provider' (set to European). A table below these fields is currently empty, with headers for various parameters including #, TSID, Orig. Net ID, Freq (MHz), Bandwidth, Constellation, Code rate, Guard interval, Transmission mode, Private data, and Services (Svc ID, LCN, Type, Visible, Manage). At the bottom of the page, there are control buttons: Add, Delete, Export, Import, Apply, and Refresh.

Figure No 12

For more information on how to create a custom NIT table please refer to "Lemco NIT creation guidelines.pdf" document in Lemco's website.



4.2.9 - "SDT" page

In this section (Figure 13), the user is able to create custom SDT table for each of the four outputs of the device. Moreover, this section offers the ability to export / import a SDT table.

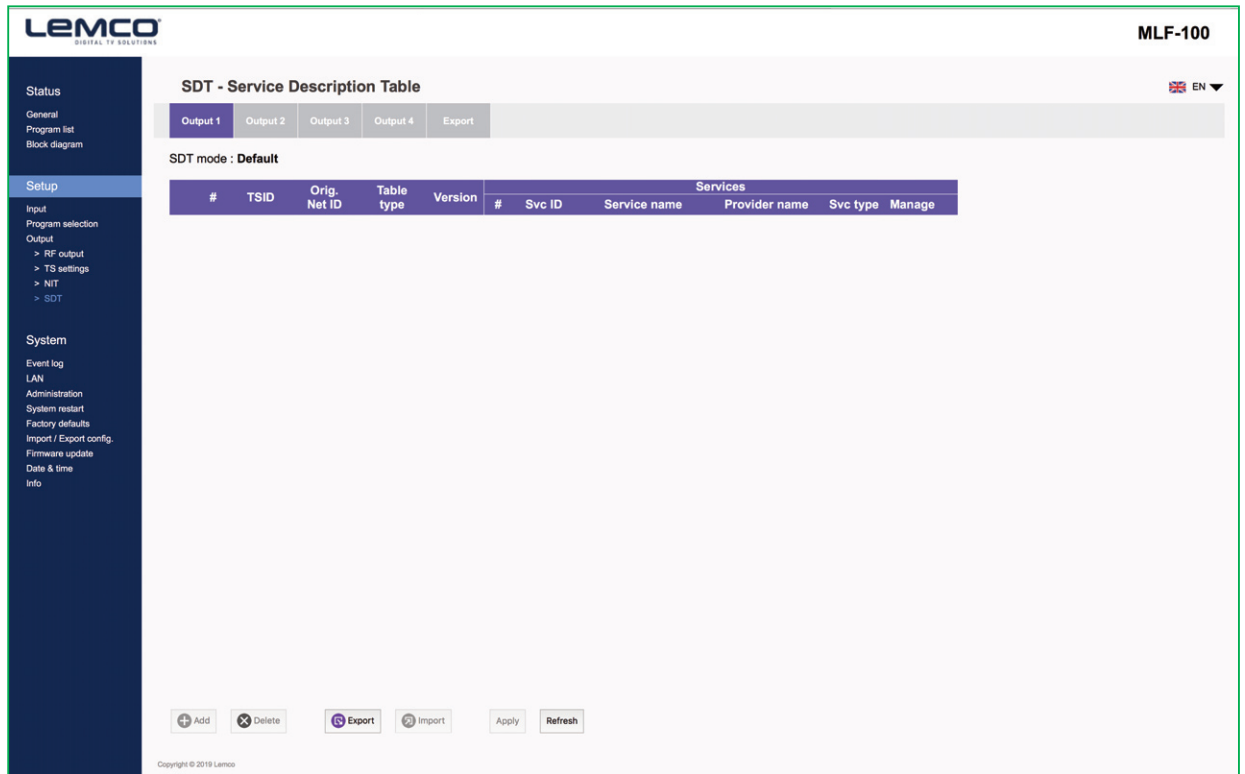

Figure No 13

For more information on how to create a custom SDT table please refer to "Lemco SDT creation guidelines.pdf" document in Lemco's website.

System

4.2.10 - "Event log" page

In "Event log" page (Figure No 14) the system logs all the events occurs in the device during its operation. These logs are divided in three different categories based on their priority as follow:

- High** Using the red color the system logs the events which are of high priority.
- Medium** Using the orange color the system logs the events which are of medium priority.
- Low** Using the red color the system logs the events which are of low priority.

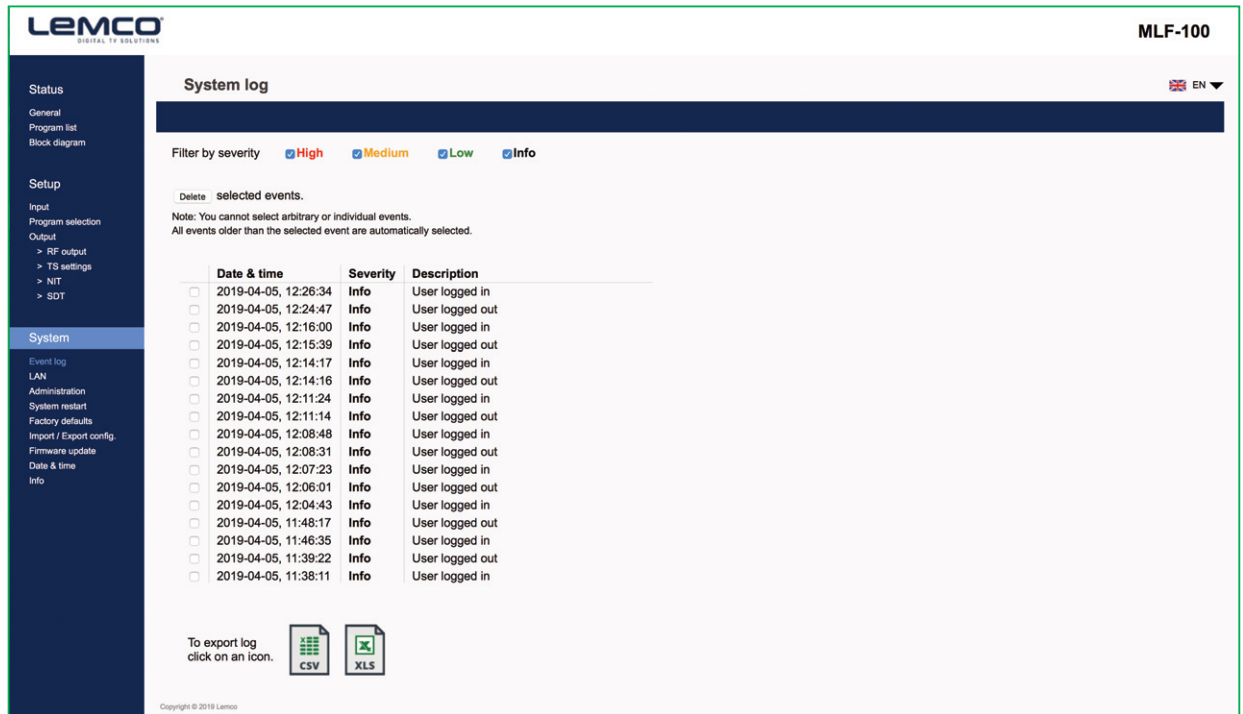

Figure No 14

The user has the ability to select which kind of events to display as well as the device gives the opportunity to export these logs as follow:

- ▮ Excel – All the program list is exported in .xlsx format
- ▮ CSV – All the program list is exported in .csv format

4.2.11 - "LAN" page

In "LAN" page (Figure No 15) the user is able to setup all the parameters of the LAN control of the device as follows:

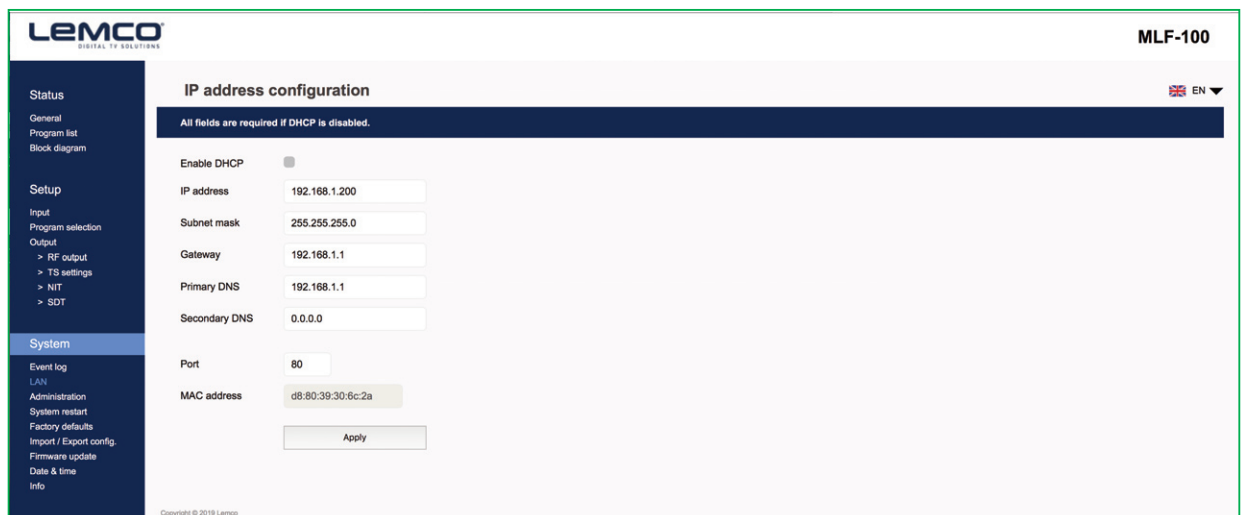

Figure No 15



- ▄ DHCP – Enable or disable DHCP
- ▄ IP address: Set a static IP address for controlling the device
- ▄ Subnet mask: Set the specific Subnet mask
- ▄ Gateway: Set the gateway’s IP address
- ▄ Primary DNS: Set the IP address of the primary DNS
- ▄ Secondary DNS: Set the IP address of the secondary DNS
- ▄ Port: Assign the control port
- ▄ MAC address: Depicts the MAC address of the LAN control

4.2.12 - “Administration” page

In “Administration” section (Figure No 16) the user is able to change the default password of the webserver.

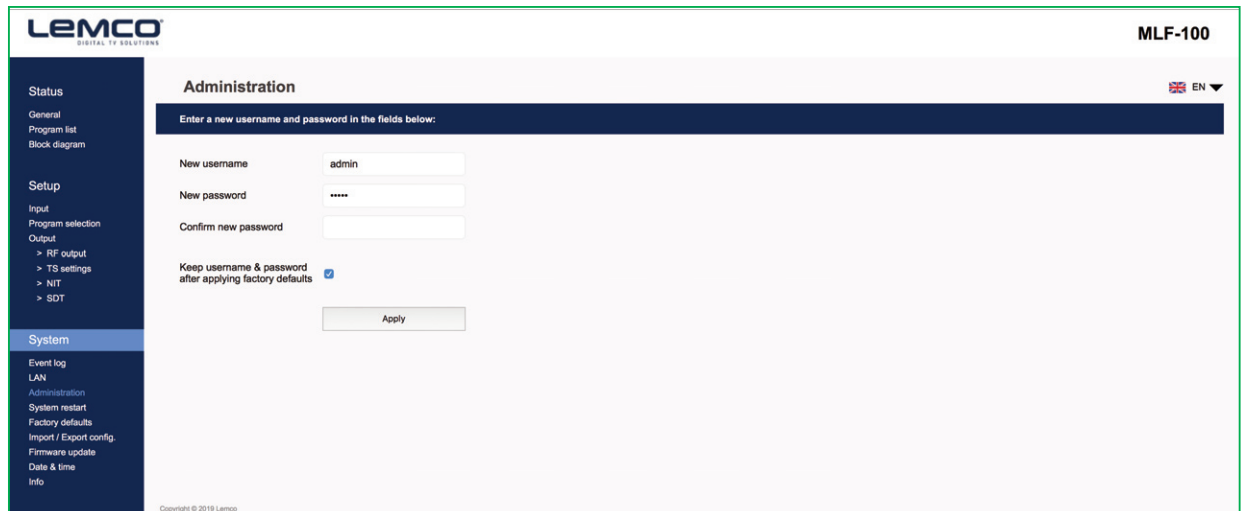

Figure No 16

Caution!

In case of factory default procedure, the username and password will be reset unless we select the check box “Keep username & password after applying factory defaults”.



4.2.13 - "System restart" page

In "System restart" section (Figure No 17) the user is able to apply a full reset to the device.

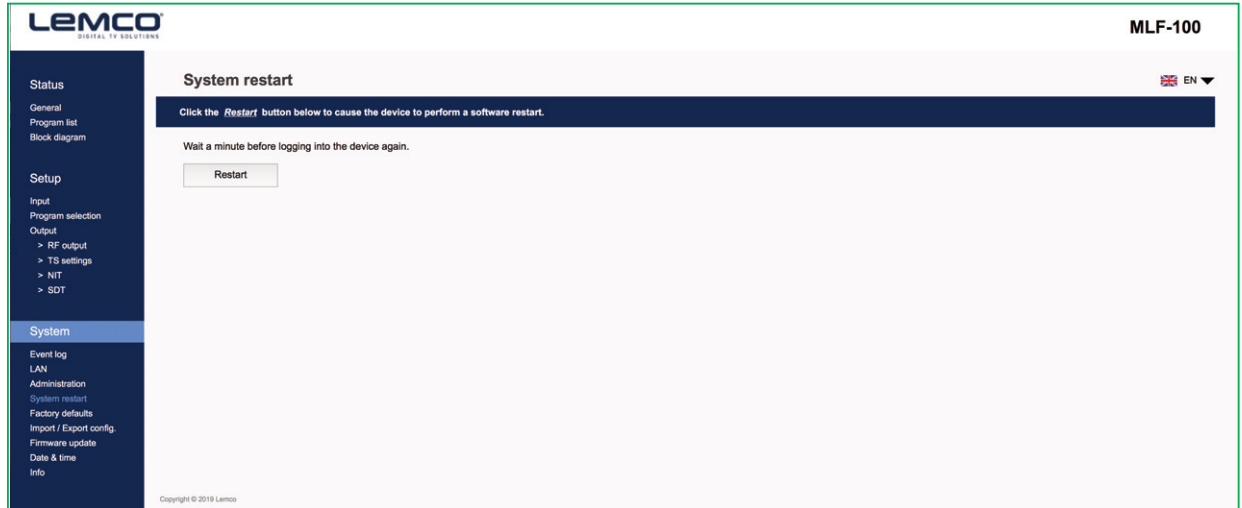

Figure No 17

4.2.14 - "Factory default" page

In "Factory default" section (Figure No 18) the user is able to apply a factory default reset either as DVB-T or DVB-C.

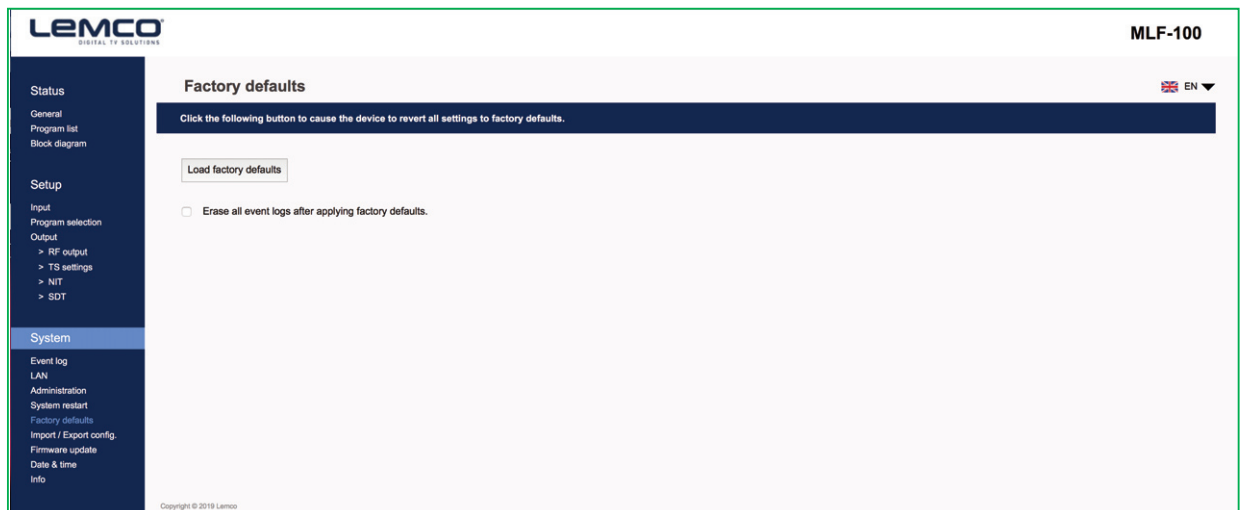

Figure No 18



4.2.15 - "Import/Export Config" page

In "Import/Export Config" section (Figure No 19) the user is able to do the following:

1. Export: Save all the configuration as a specific file
2. Import: Upload a previously save configuration file.

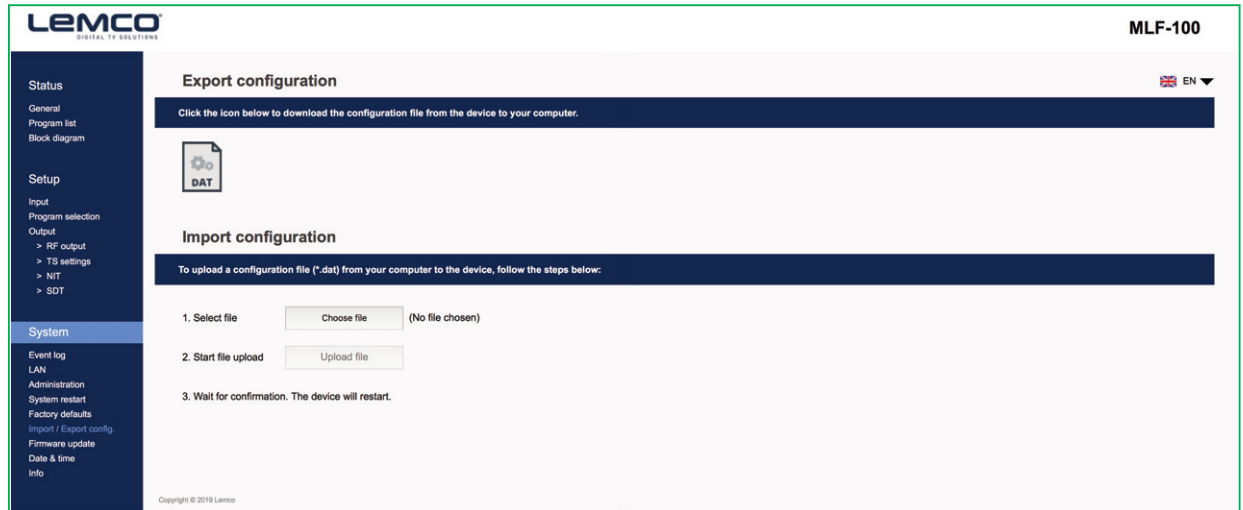

Figure No 19

4.2.16 - "Firmware update" page

In "Firmware update" (Figure No 20) section the user is able to upload a new firmware update using the appropriate file.

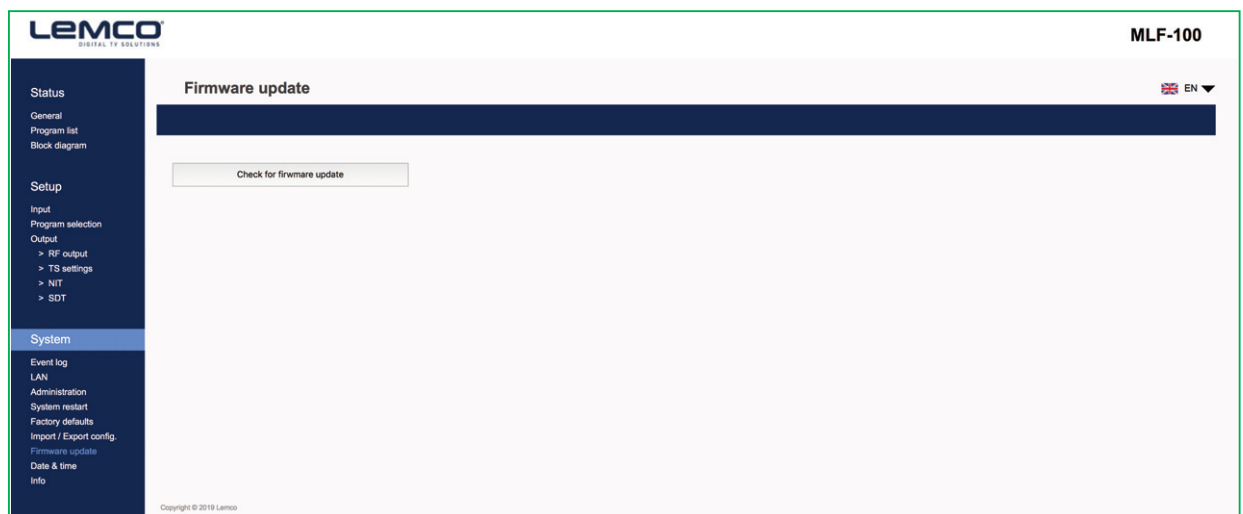

Figure No 20



4.2.17 - "Date & Time" page

In "Date & Time" (Figure No 21) section the user is able to select the NTP server in order for the device to receive the date and time as well as to set the timezone of his country.

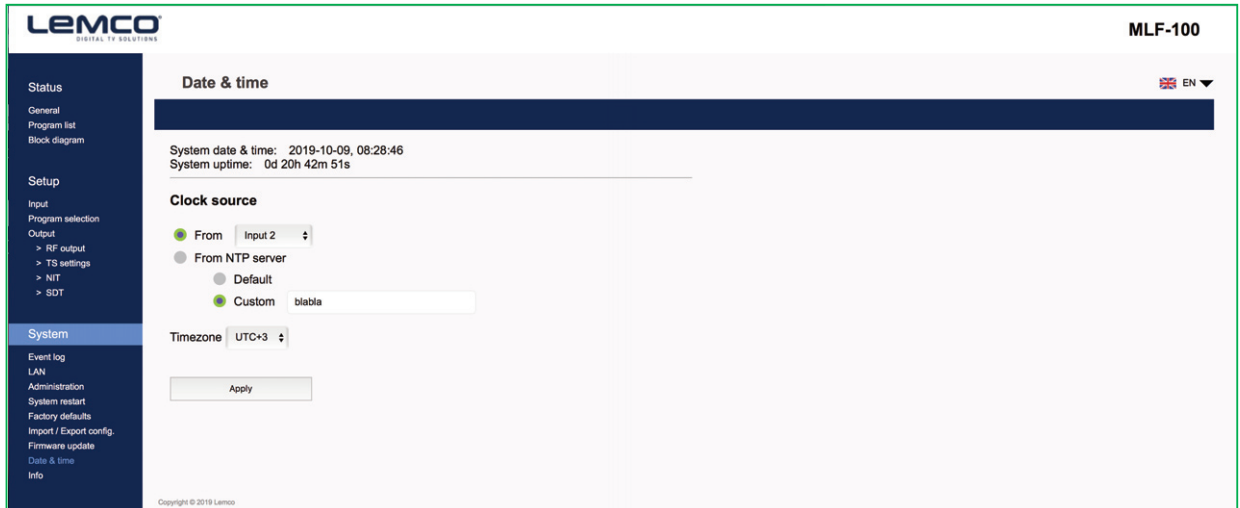

Figure No 21

4.2.18 - "Info" page

In "Info" (Figure No 22) section the user is able to see the serial No of the device as well as firmware and hardware versions.

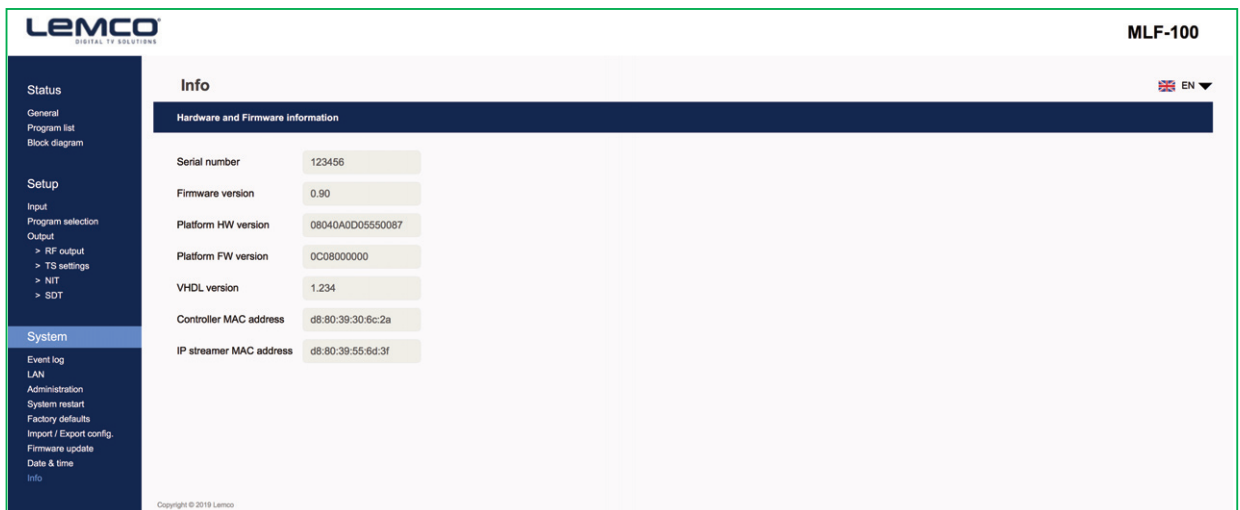

Figure No 22



5. TECHNICAL SPECIFICATIONS

Input Specifications

Input

Type	4 x DVB-S/S2/T/T2/C	
Frequencies	950...2150 MHz	DVB-S/S2
	118...900MHz	DVB-T/T2/C
Connector	75Ω - F, female	

LNB

Voltage	OFF / 13V / 18V
Current	< 400mA
22 KHz signal	On / Off
-Voltage	0.65V ±0.35V
-Frequency	22 KHz ±4Hz
-DiSEqC	1.0 (Port A, B, C, D)

DVB-S

Standard	EN 300-421 V1.1.2
Symbol Rate	1 - 55 MBaud
Roll off factor	0.2, 0.25, 0.35
Code Rate	1/2, 2/3, 3/4, 5/6, 7/8 (automatic)
Spectral Inversion	Reverse, Non-reverse (automatic)

DVB-S2

Standard	EN 307-421 V1.2.1
Constellation	QPSK, 8PSK (automatic)
Symbol rate	1 - 55 MBaud (QPSK) 1 - 45 MBaud (8PSK)
Roll off factor	0.2, 0.25, 0.35 (automatic)
Code rate	1/2, 3/5, 2/3, 3/4, 4/5, 5/6, 8/9, 8/10 (QPSK- automatic) 3/5, 2/3, 3/4, 5/6, 8/9, 9/10 (8PSK- automatic)
Spectral inversion	Reverse, Non-reverse (automatic)

DVB-T

Standard	EN 300-744 V1.6.1
Bandwidth	6, 7, 8 MHz
Mode	2K, 8K
Constellation	QPSK, 16QAM, 64QAM
Guard interval	1/4, 1/8, 1/16, 1/32
Code rate	1/2, 2/3, 3/4, 5/6, 7/8

DVB-T2 / T2 Lite

Standard	EN 302-755 V1.3.1
Bandwidth	5, 6, 7, 8 MHz
Mode	1K, 2K, 4K, 8K, 16K, 32K (Included extended mode)
Constellation	QPSK, 16QAM, 64QAM, 256QAM
Code rate	1/2, 3/5, 2/3, 3/4, 4/5, 5/6



ITU-T J.83

Standard	Annex A(DVB-C), B(US cable),C
Bandwidth	5, 6, 7, 8 MHz
Mode	Automatic modulation detection
Constellation	16QAM, 32QAM, 64QAM, 128QAM, 256QAM

Output Specifications

DVB-T

Standard	EN 300-744
Bandwidth	5, 6, 7, 8 MHz
Mode	2K, 8K
Constellation	QPSK, 16QAM, 64QAM
Guard interval	1/4, 1/8, 1/16, 1/32
Code rate	1/2, 2/3, 3/4, 5/6, 7/8

ITU-T J.83

Standard	Annex A(DVB-C)
Bandwidth	5, 6, 7, 8 MHz
Mode	2K, 8K
Constellation	16QAM, 32QAM, 64QAM, 128QAM, 256QAM
Symbol rate	1-7.2 Ms/s

RF Output

Type	4 x RF out in adjacent channels
Output Frequencies	110...950 MHz (1 Hz step)
Output Level	90dBμV
Connector	75Ω - F, female
Output Attenuator	0...-20dB
MER	>42dB
Output loop-through loss	<1dB

Transport Stream Processing

Services	User selection by service names
Automatic Regeneration	PAT, CAT, SDT, PMTs, EITs tables
NIT/SDT	Pass-through, custom, automatic
PCR	re-stamping
LCN support	Yes

Programming Interface

Ethernet webserver	Yes, embedded webserver
Speed	10/100 Mbps
Connector	RJ45
Browser compatibility	Chrome, Firefox, Safari, Opera, Edge etc. (Must support HTML v5.0)
SNMP support	Yes
SNMP version	v2.0

General

Power Supply	2 x +12VDC
Power supply consumption	1.8A max.
Operating Temperature	0 °C to 40 °C
Storage Temperature	-10 °C to +70 °C
Humidity	Up to 90%
Dimensions	235 x 115 x 48 mm
Weight	0.45 Kg



6. DIMENSIONS

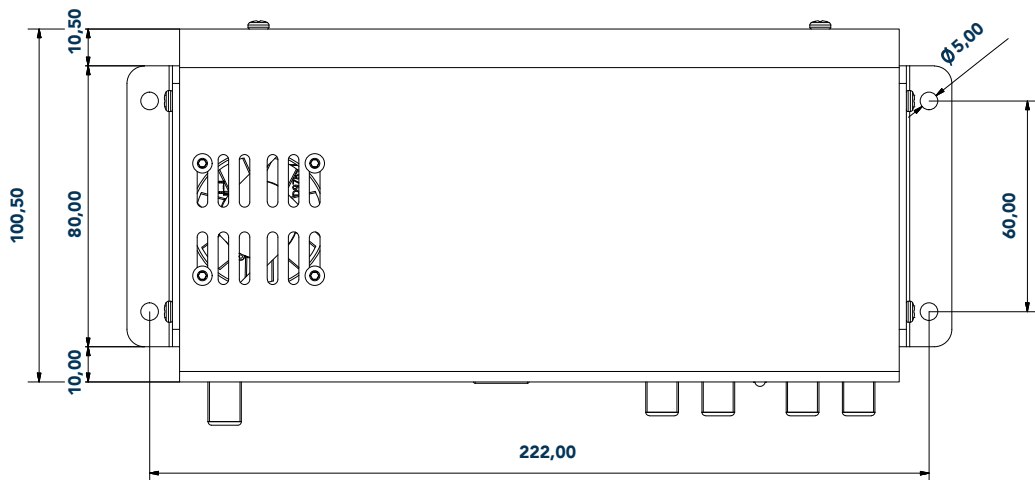
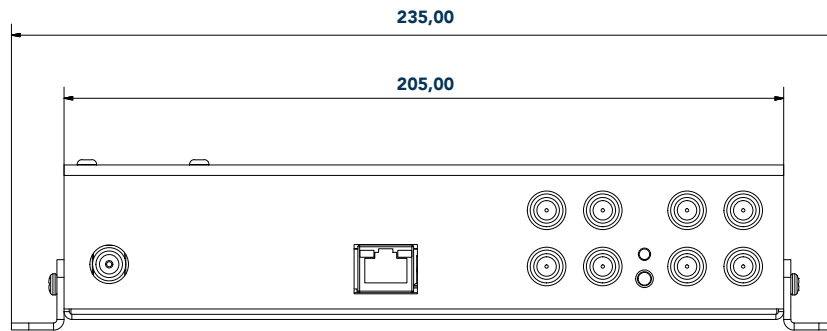
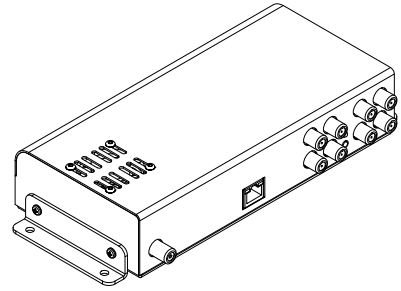
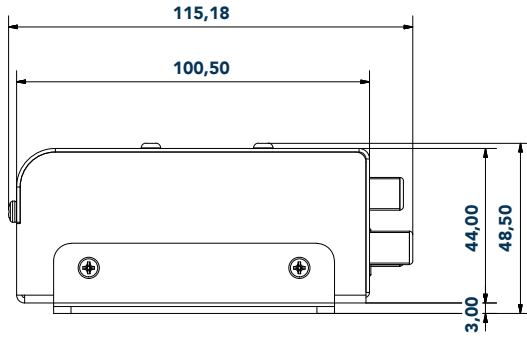

*dimensions in mm



7. LEMCO LIMITED WARRANTY

This Lemco unit is guaranteed against defects in workmanship and materials for a period of five (5) years beginning on the date of purchase of the product. During the applicable warranty period, Lemco will repair or replace at our sole option, without charge, any defective component part of the purchased unit. The unit is to be delivered packed in adequate packing AFTER an authorization for return has been received.

The owner's responsibilities are to use the instrument in accordance with its written instructions, to provide transport to and from our facilities in the event service is required, and to provide proof of purchase if requested.

Our warranty does not cover any problem resulting from:

- (a) accident; abuse; neglect; shock; electrostatic discharge; heat or humidity beyond product specifications; improper installation, operation, maintenance or modification
- (b) any misuse contrary to the instructions in the user manual
- (c) malfunctions caused by other equipment.

WARNING!!

Our limited warranty is considered void if a product is returned with removed, damaged or tampered labels or any alterations (including removal of any component or external cover) carried out by unauthorized personnel.

OUT OF WARRANTY SERVICING

We repair and service units of our production even once the warranty has expired, if this is economically the best solution to the customer.

The mechanical and electronic spare parts are replaceable for a five-year period after production when the circuits are assembled with discrete components. When integrated circuits are used, the supply of spare parts is guaranteed up to the depletion of our stock and, depending on the possibility of procuring them on the worldwide market.

To avoid any unnecessary loss of time, it is very important that the instrument be returned to our premises accompanied by a proper delivery note, duly completed with all the required information, as per the legal dispositions currently enforced.



8. WARNINGS

Content warning

This document contains preliminary information about a product of Lemco company. Lemco reserves the right to make any changes or modifications at any time without prior notice.

APPENDIX A

DVB-T bitrates (Mbit/s) for **8 MHz** bandwidth (non-hierarchical systems)

Modulation	Coding Rate	Guard Interval			
		1/4	1/8	1/16	1/32
QPSK	1/2	4.976	5.529	5.855	6.032
	2/3	6.635	7.373	7.806	8.043
	3/4	7.465	8.294	8.782	9.048
	5/6	8.294	9.216	9.758	10.053
	7/8	8.709	9.676	10.246	10.556
16-QAM	1/2	9.953	11.059	11.709	12.064
	2/3	13.271	14.745	15.612	16.086
	3/4	14.929	16.588	17.564	18.096
	5/6	16.588	18.431	19.516	20.107
	7/8	17.418	19.353	20.491	21.112
64-QAM	1/2	14.929	16.588	17.564	18.096
	2/3	19.906	22.118	23.419	24.128
	3/4	22.394	24.882	26.346	27.144
	5/6	24.882	27.647	29.273	30.160
	7/8	26.126	29.029	30.737	31.668



DVB-T bitrates (Mbit/s) for 7 MHz bandwidth (non-hierarchical systems)

Modulation	Coding Rate	Guard Interval			
		1/4	1/8	1/16	1/32
QPSK	1/2	4.354	4.838	5.123	5.278
	2/3	5.806	6.451	6.830	7.037
	3/4	6.532	7.257	7.684	7.917
	5/6	7.257	8.064	8.538	8.797
	7/8	7.620	8.467	8.965	9.237
16-QAM	1/2	8.709	9.676	10.246	10.556
	2/3	11.612	12.902	13.661	14.075
	3/4	13.063	14.515	15.369	15.834
	5/6	14.515	16.127	17.076	17.594
	7/8	15.240	16.934	17.930	18.473
64-QAM	1/2	13.063	14.515	15.369	15.834
	2/3	17.418	19.353	20.491	21.112
	3/4	19.595	21.772	23.053	23.751
	5/6	21.772	24.191	25.614	26.390
	7/8	22.861	25.401	26.895	27.710

DVB-T bitrates (Mbit/s) for 6 MHz bandwidth (non-hierarchical systems)

Modulation	Coding Rate	Guard Interval			
		1/4	1/8	1/16	1/32
QPSK	1/2	3.732	4.147	4.391	4.524
	2/3	4.976	5.529	5.855	6.032
	3/4	5.599	6.221	6.587	6.786
	5/6	6.221	6.912	7.318	7.540
	7/8	6.532	7.257	7.684	7.917
16-QAM	1/2	7.465	8.294	8.782	9.048
	2/3	9.953	11.059	11.709	12.064
	3/4	11.197	12.441	13.173	13.572
	5/6	12.441	13.824	14.637	15.080
	7/8	13.063	14.515	15.369	15.834
64-QAM	1/2	11.197	12.441	13.193	13.572
	2/3	14.929	16.588	17.564	18.096
	3/4	16.796	18.662	19.760	20.358
	5/6	18.662	20.735	21.995	22.620
	7/8	19.595	21.772	23.053	23.751



9. NOTES



LEMCO[®]

DIGITAL TV SOLUTIONS

Contact Information

Lemco IKE

Latheas 46 - 13678

Athens - Greece

www.lemco.tv

Tel: +30 210 2811401

Fax: +30 210 2825755

Email: info@lemco.gr

follow us:  facebook.com/Lemco  twitter.com/lemcodtv  linkedin.com/company/lemco